

Genomics of Diffuse Large B Cell Lymphoma: Role of Mutations of Non-Coding Regulatory Sequences

Riccardo Dalla Favera, MD
Columbia University

7th Postgraduate Lymphoma Conference

Rome
March 16-17, 2023

I have the following financial relationships to disclose:

Consultant for: NeoGenomics, Astra Zeneca, DiaTech

Research support: Astra Zeneca

Germinal Centers and Lymphomagenesis

Basso & Dalla-Favera, Nat Rev Immunology, 2015

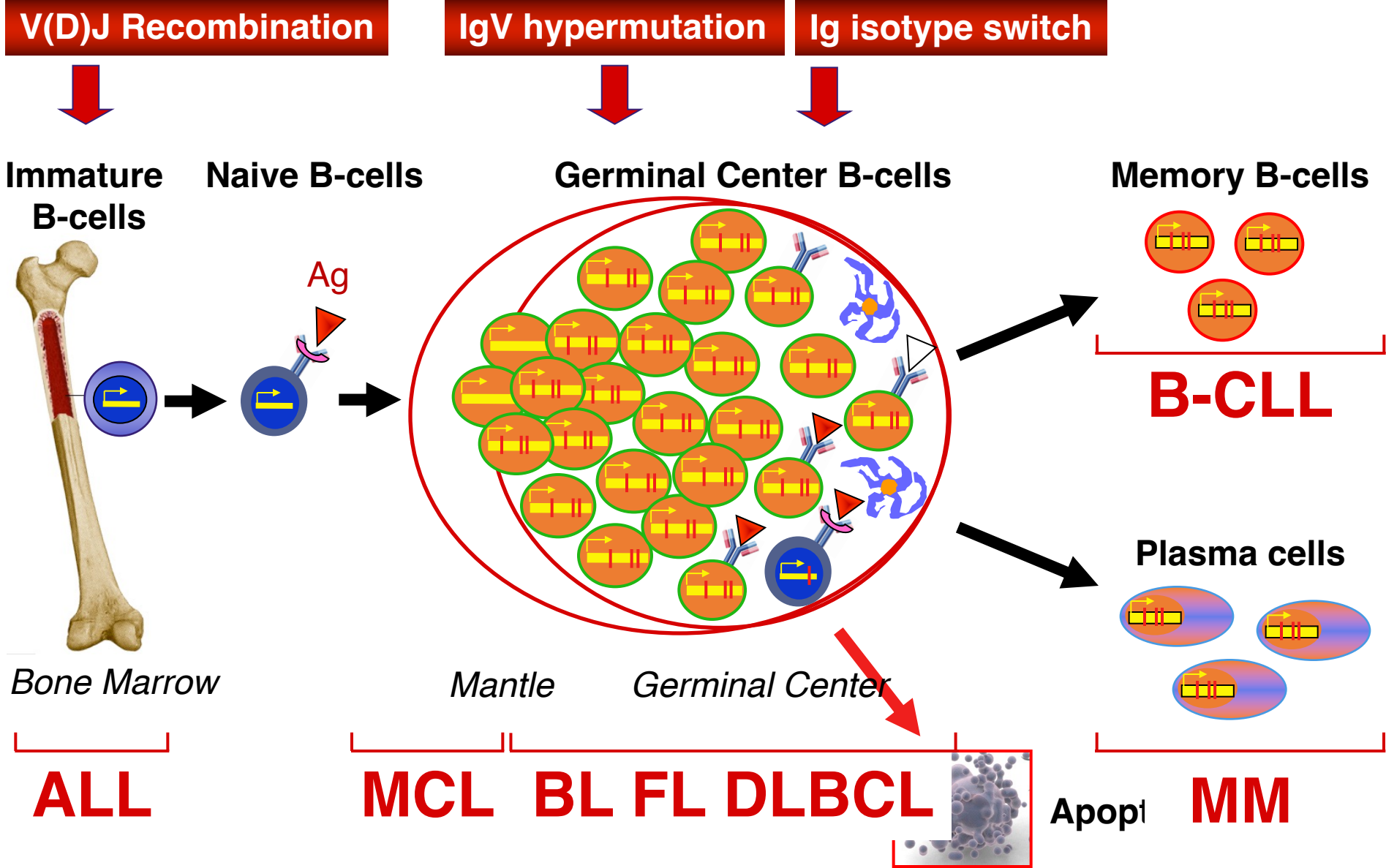

AID-mediated hypermutation is required for lymphomagenesis

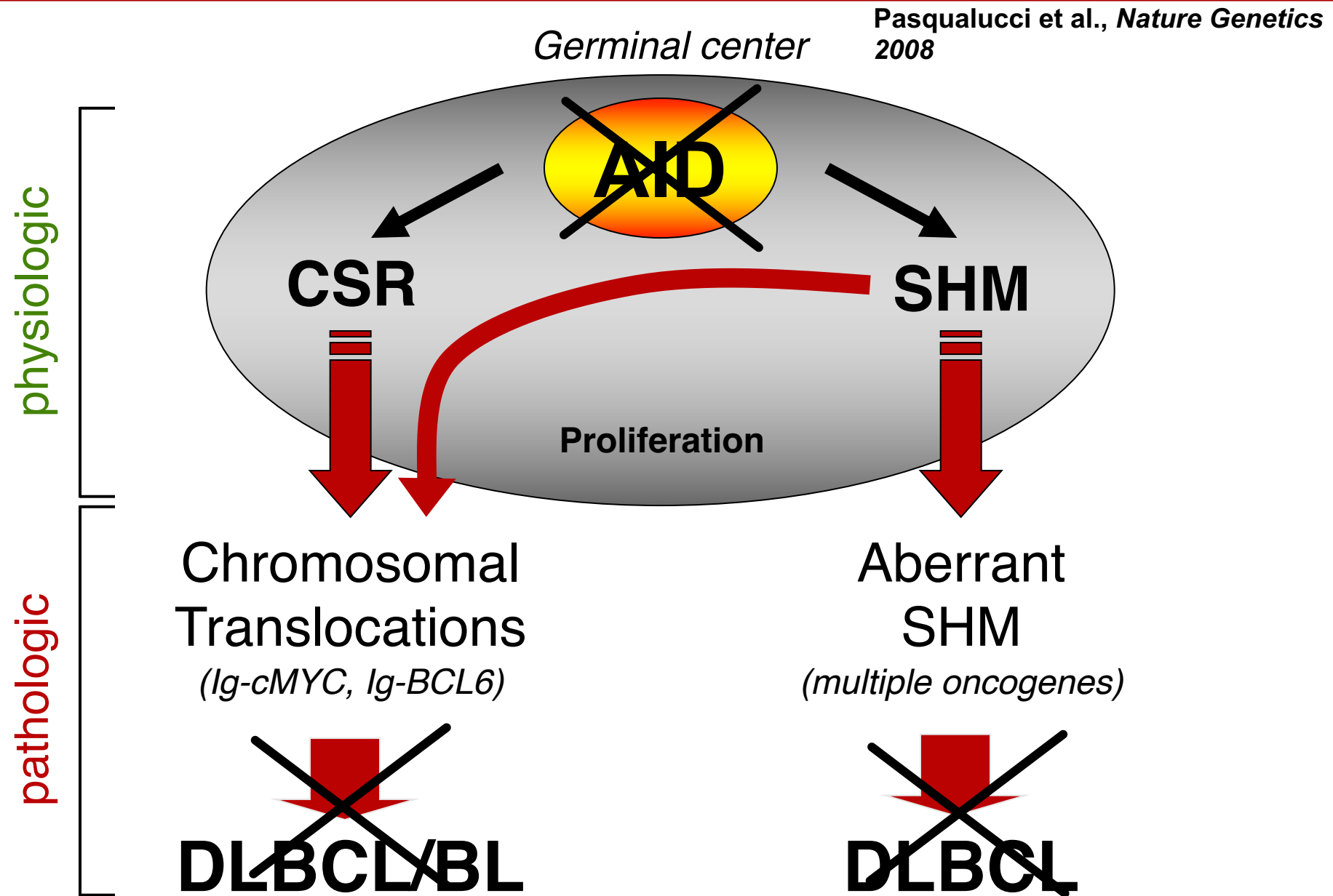

Common and distinct targets of genetic lesion in DLBCL COO molecular subtypes

Histone/chromatin modification

Acetyl-transferases (CREBBP, EP300); *Methyl-transferases* (KMT2D)

BCL6 deregulated activity

BCL6 translocations, MEF2B mutations

Escape from immune surveillance (CTL + NK)

B2M mutations, HLA-I loss, CD58 mutations

Shared (EZB, BN2, A53 etc)

- BCL2 *translocations* 25-30%
- MYC *translocations* 10%
- EZH2 *mutations* 22%
- GNA13/S1PR2 *mut* 20-30%
- TNFRSF14 *mutations* 15-20%

GCB-DLBCL (EZB)

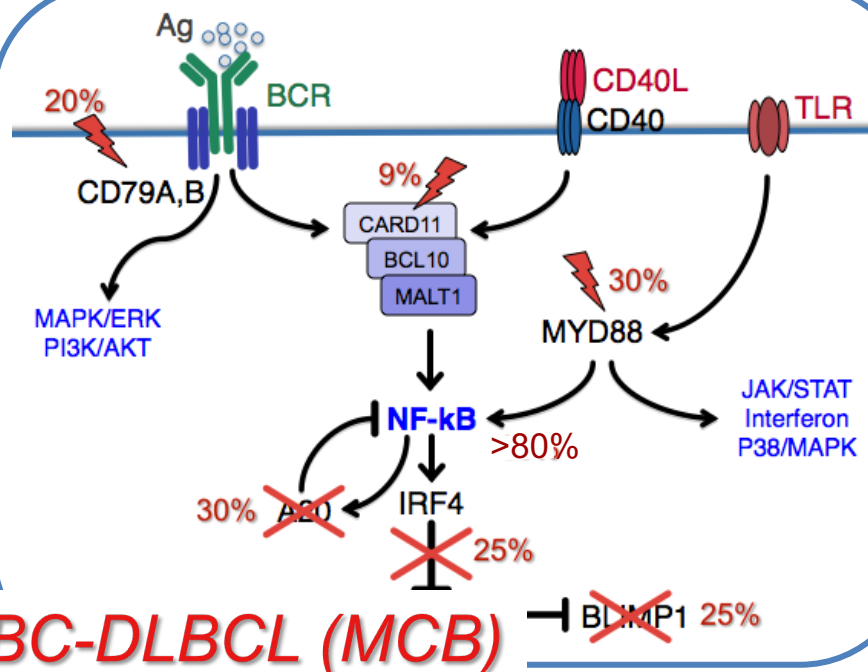

Genomic classification of DLBCL

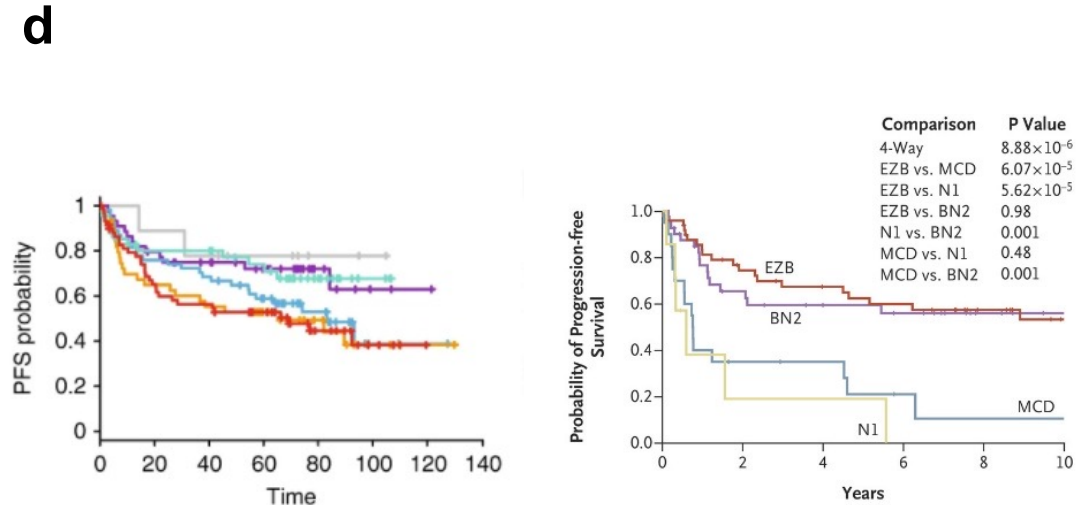
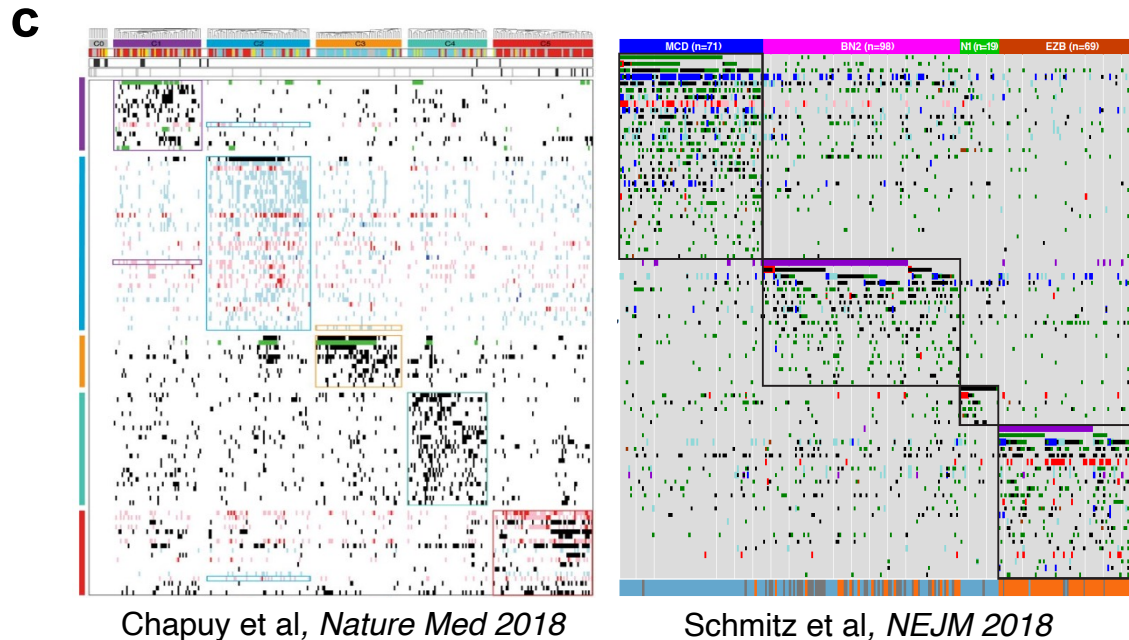
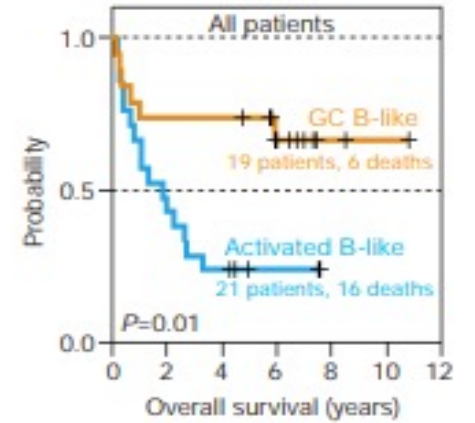
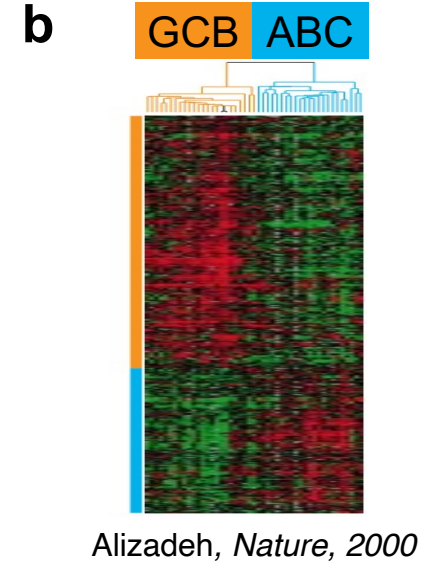
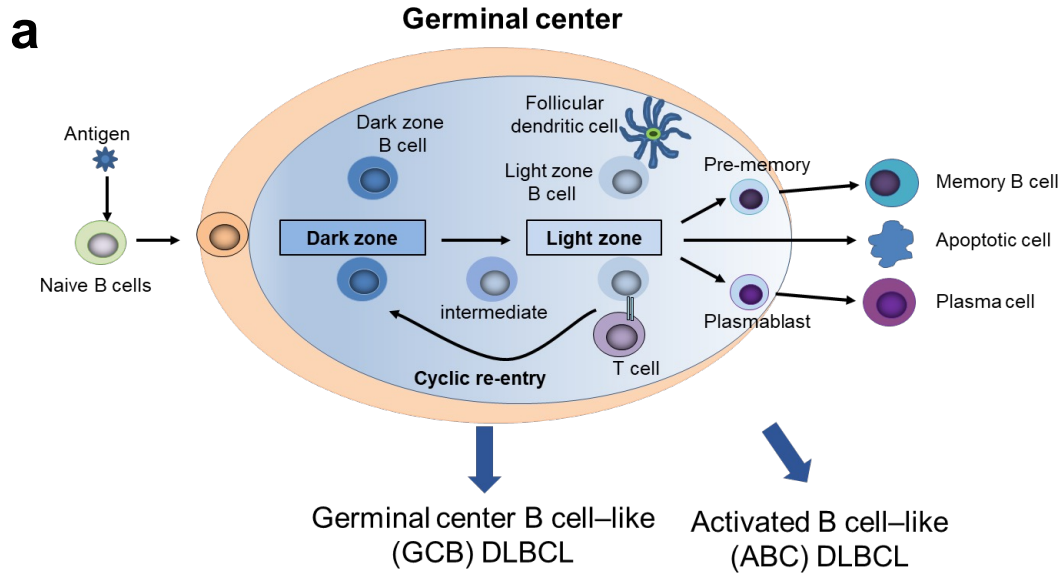

Protein coding genes represent <2% of the human genome: what about the non-coding genome?

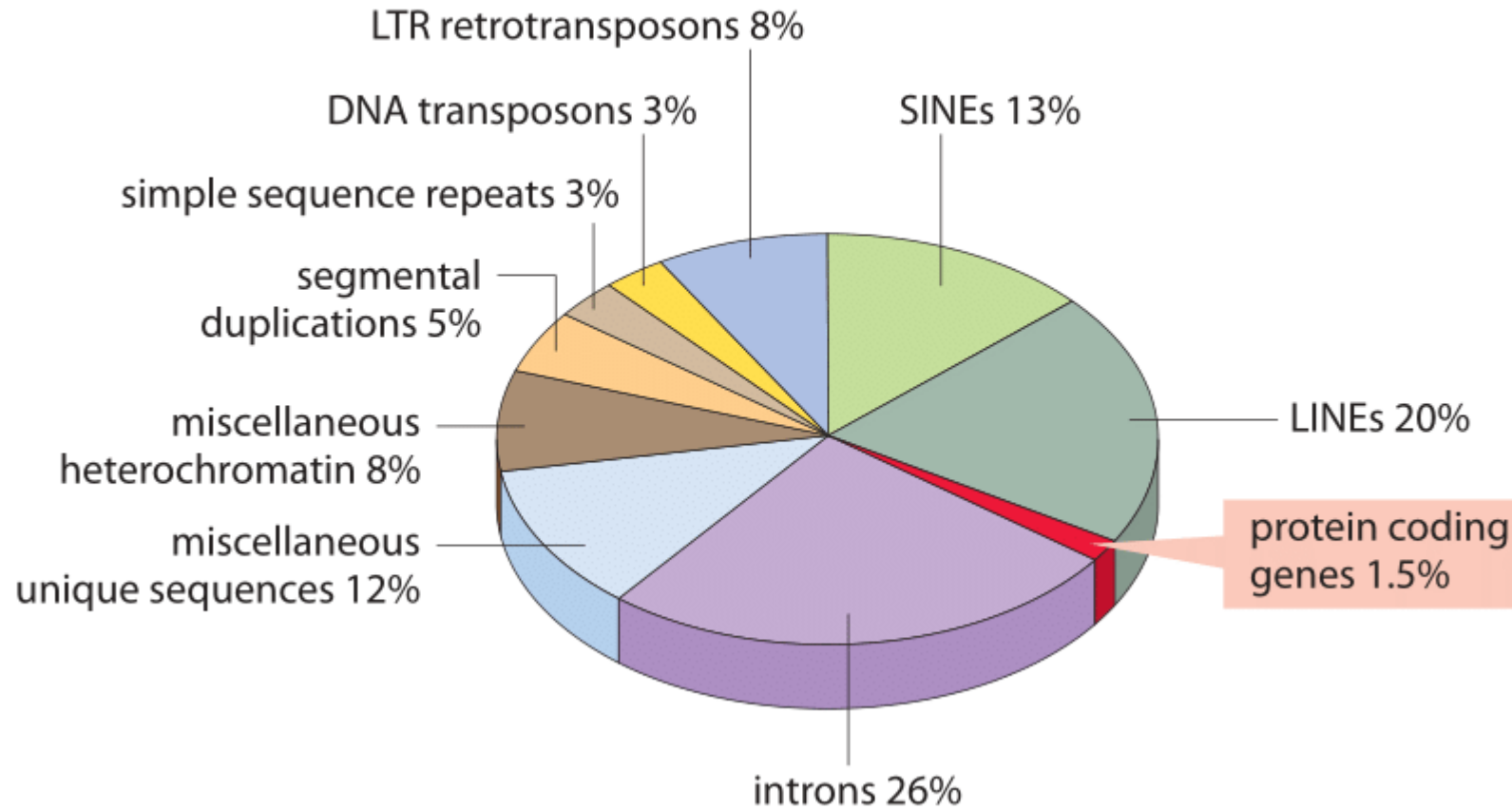

Genome-wide analysis of non-coding regulatory mutations in Diffuse Large B-cell Lymphoma

Identification of functional non-coding mutations (enhancer/super-enhancer)

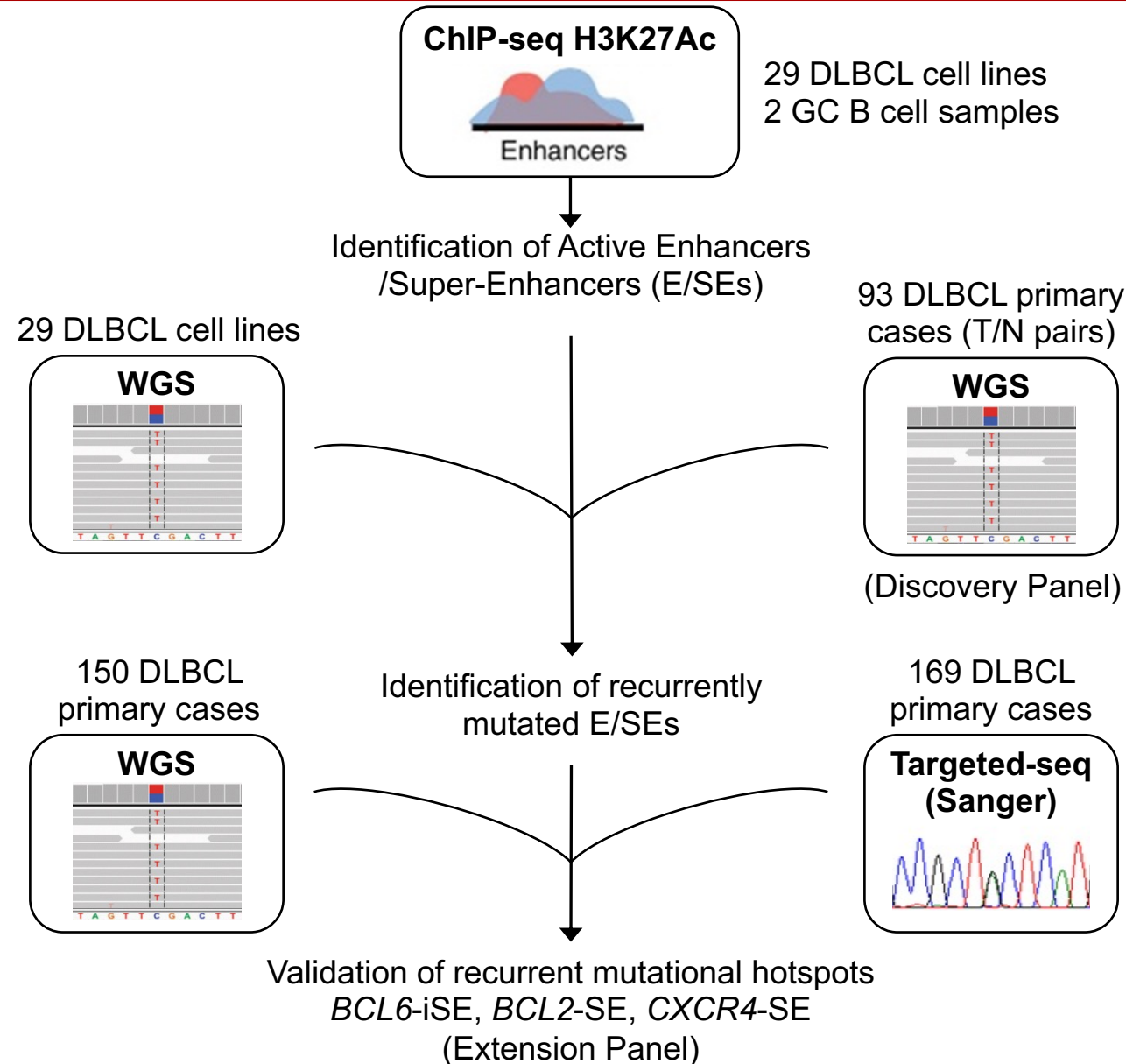

Shared and subtype-specific SEs in DLBCL

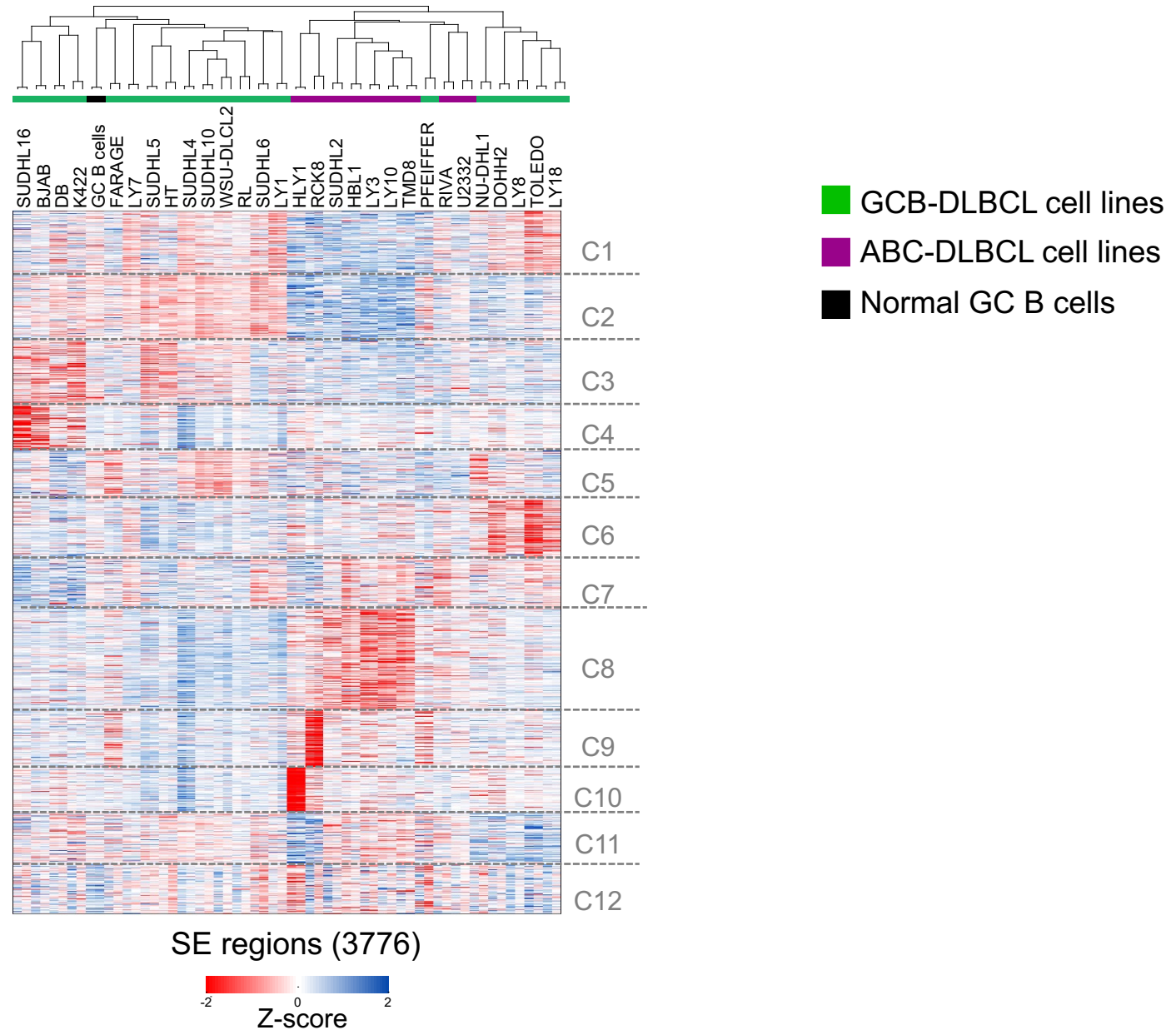

SE regions are hypermutated in DLBCL cell lines

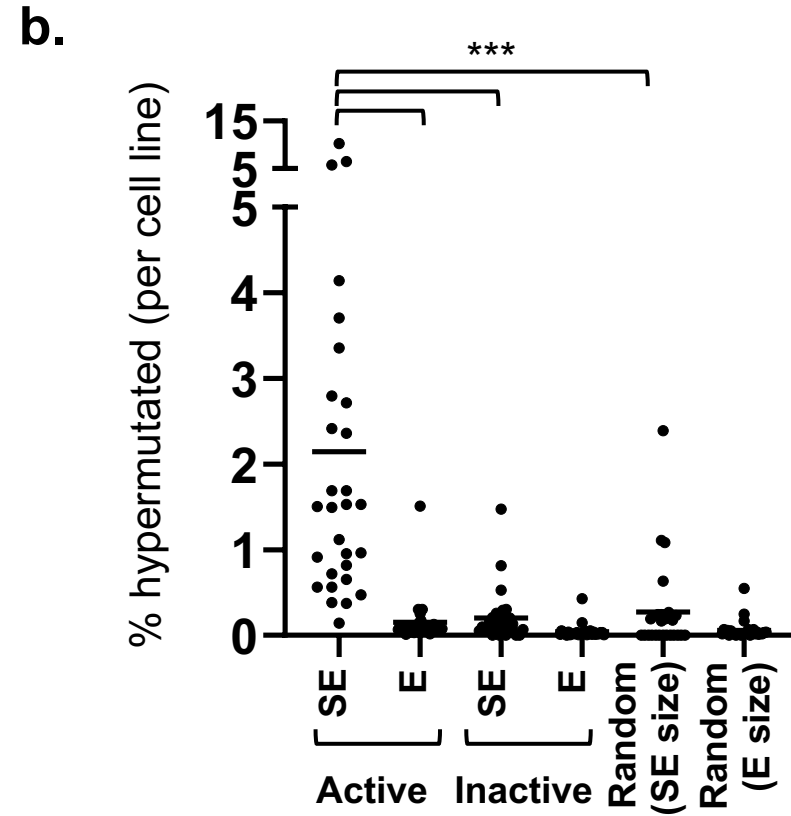
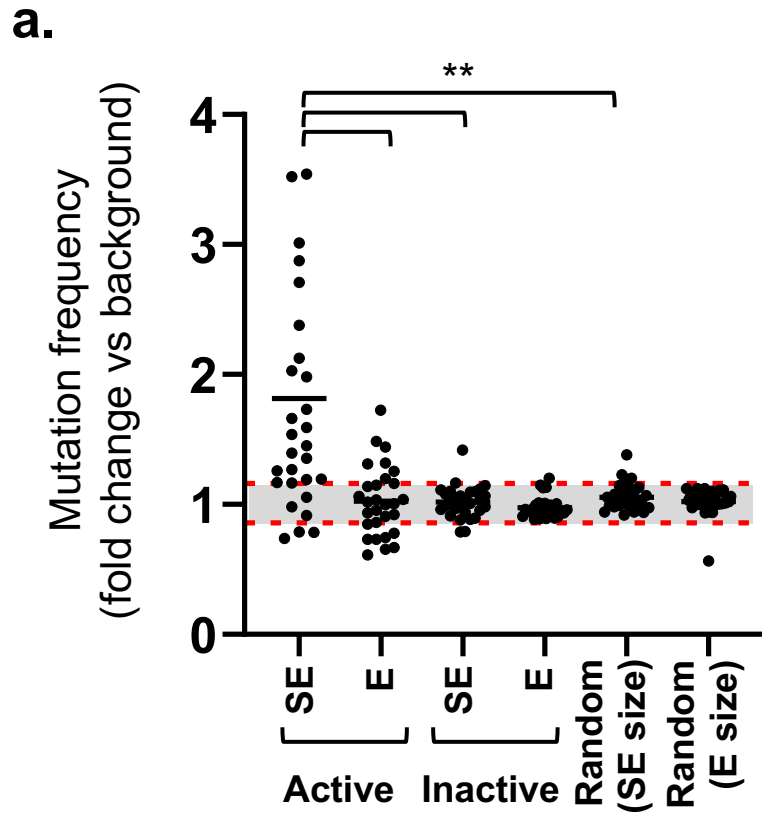

Hypermutated E/SEs:

- ≥ 3 mut with intermutation distance ≤ 1 kb
- Mutation frequency significantly higher with respect to background (mutations in the rest of the genome)

** $p < 0.01$, paired t-test

*** $p < 0.001$, paired t-test

SEs are hypermutated in DLBCL primary cases

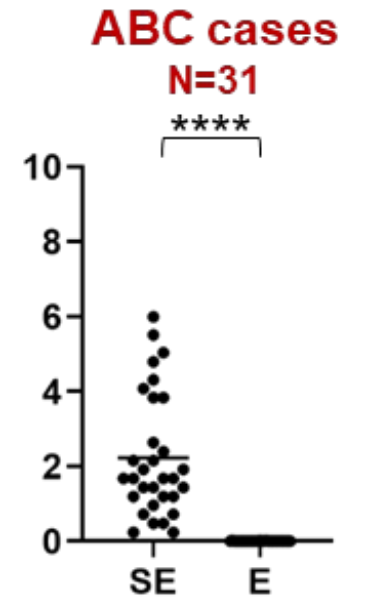
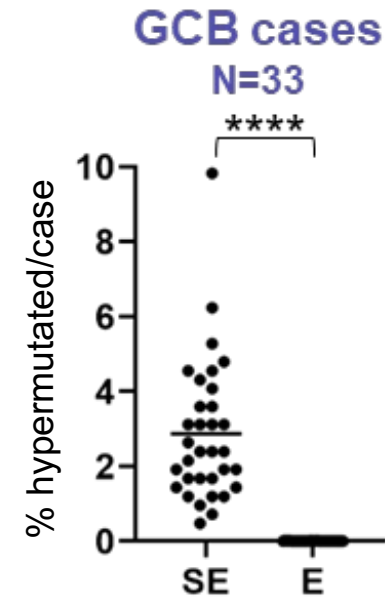
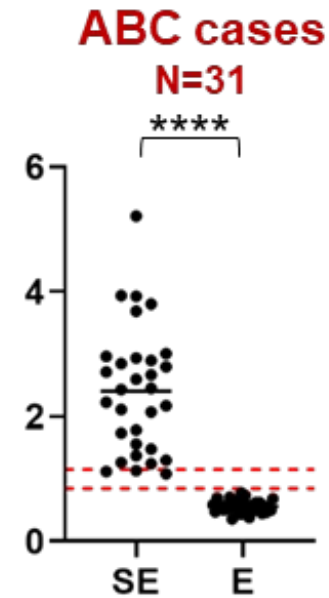
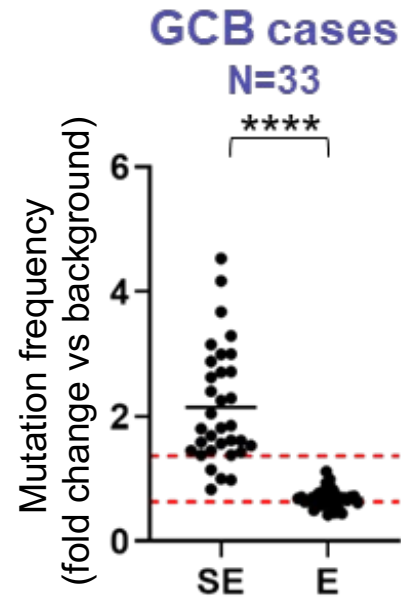
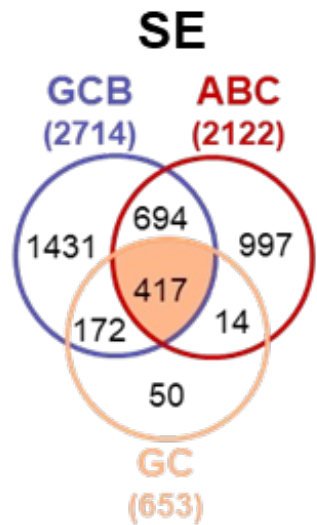

Mutational signatures in SEs display AID hallmarks

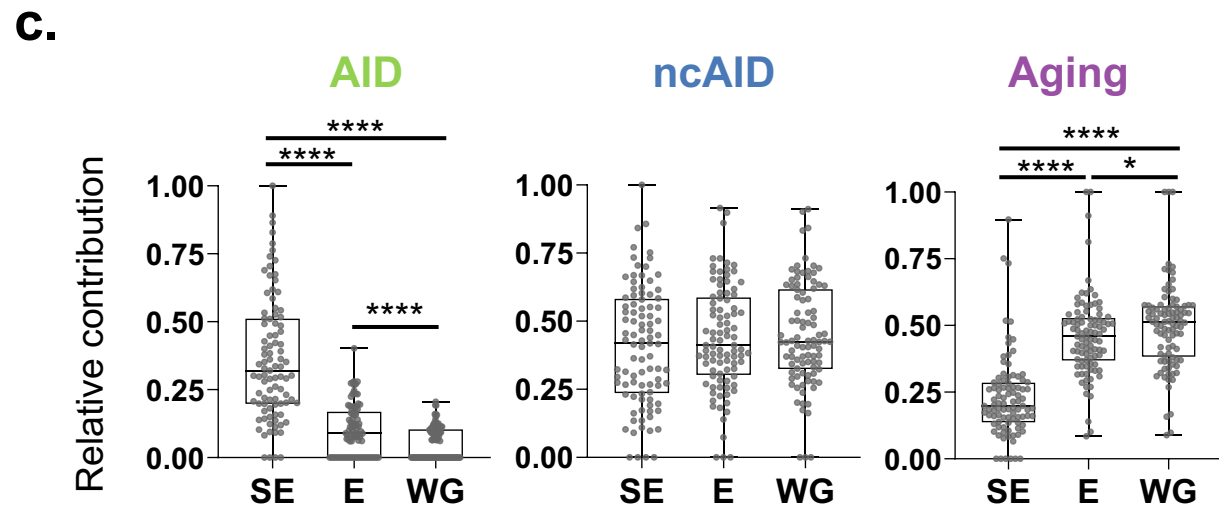
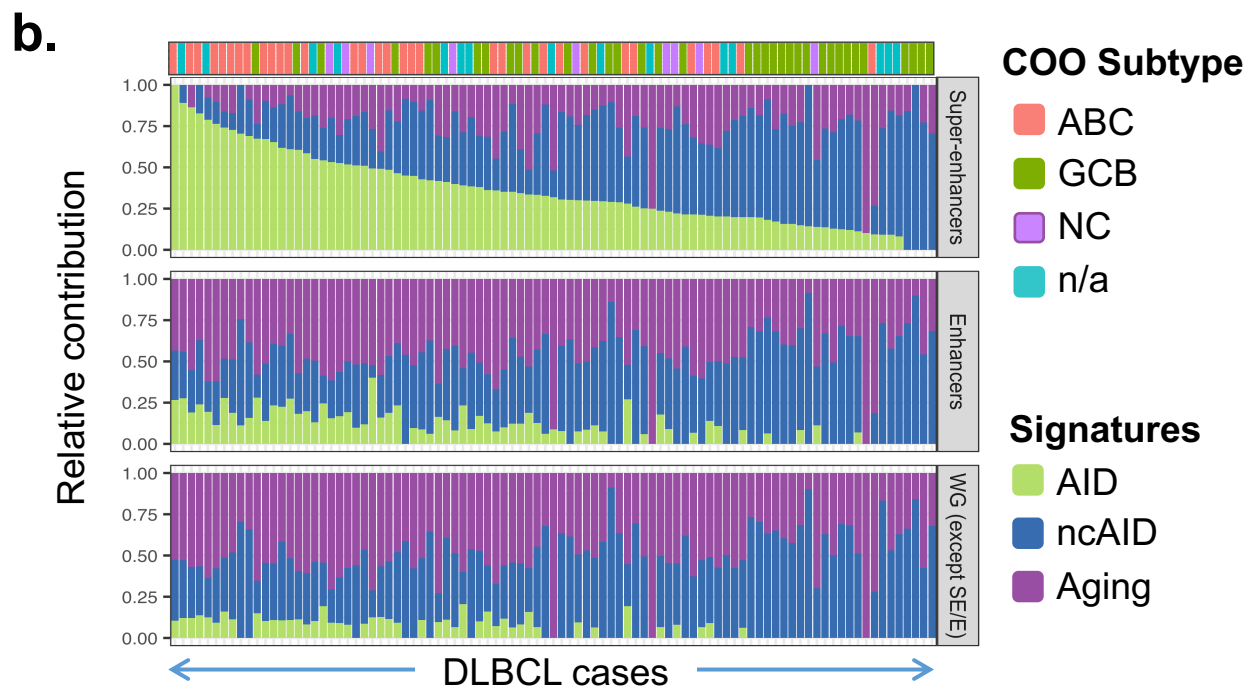
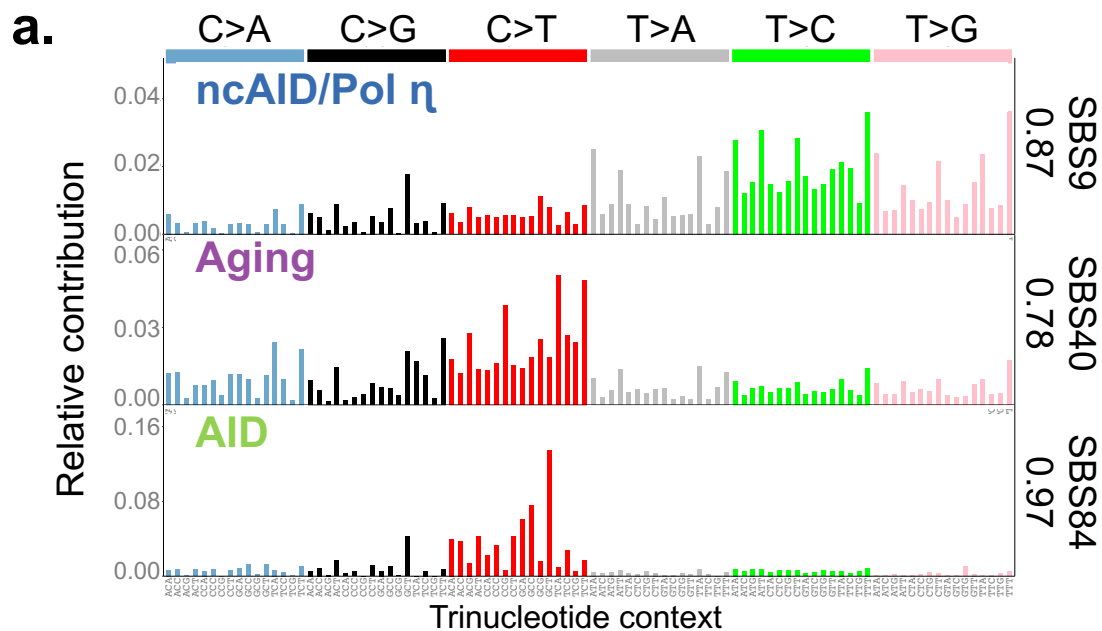

d. Inverse contribution of ncAID vs AID signature in SEs

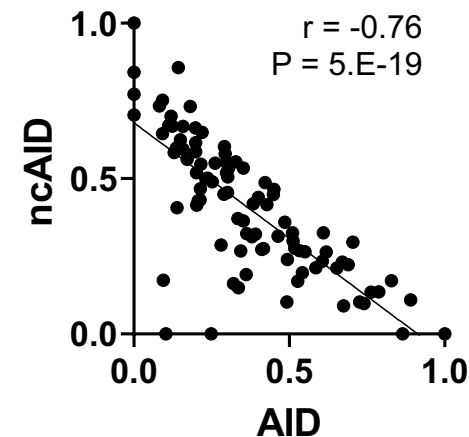

Candidate genes linked to recurrently mutated SEs are enriched in lymphoma oncogenes

a.

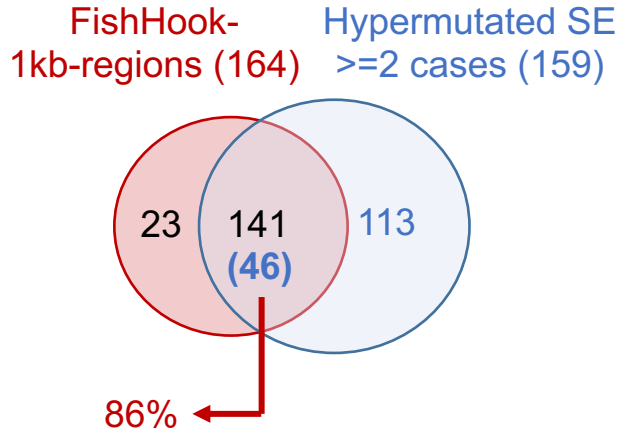

b.

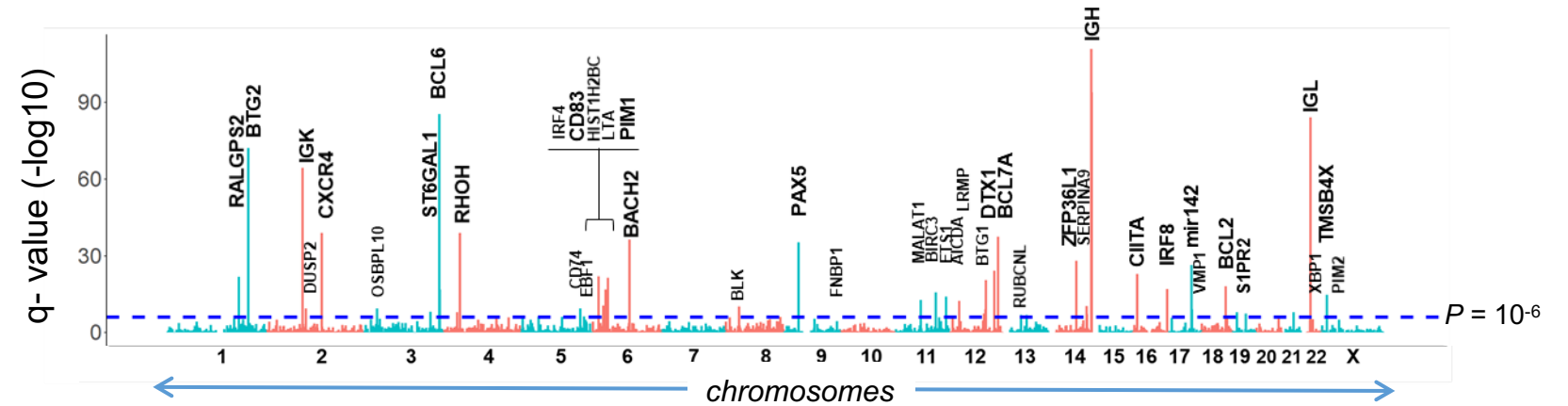

c.

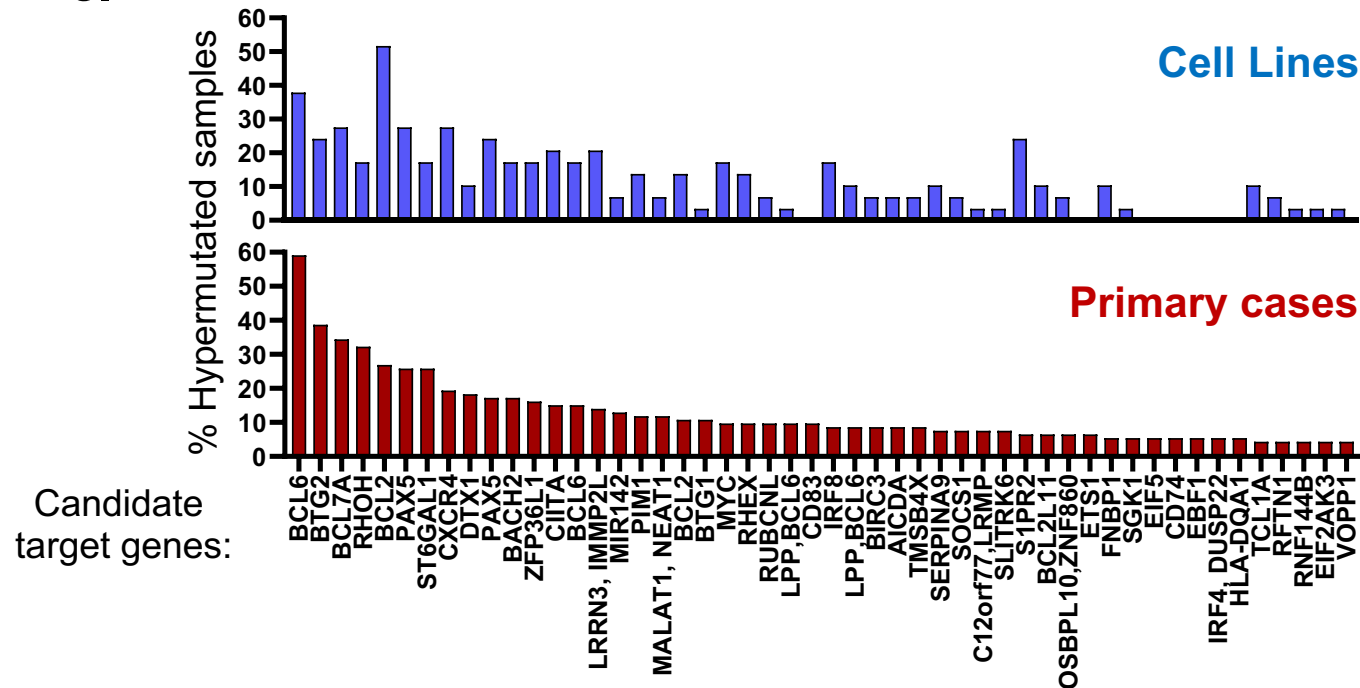

A highly recurrent mutational hotspot in the BCL6 intragenic SE

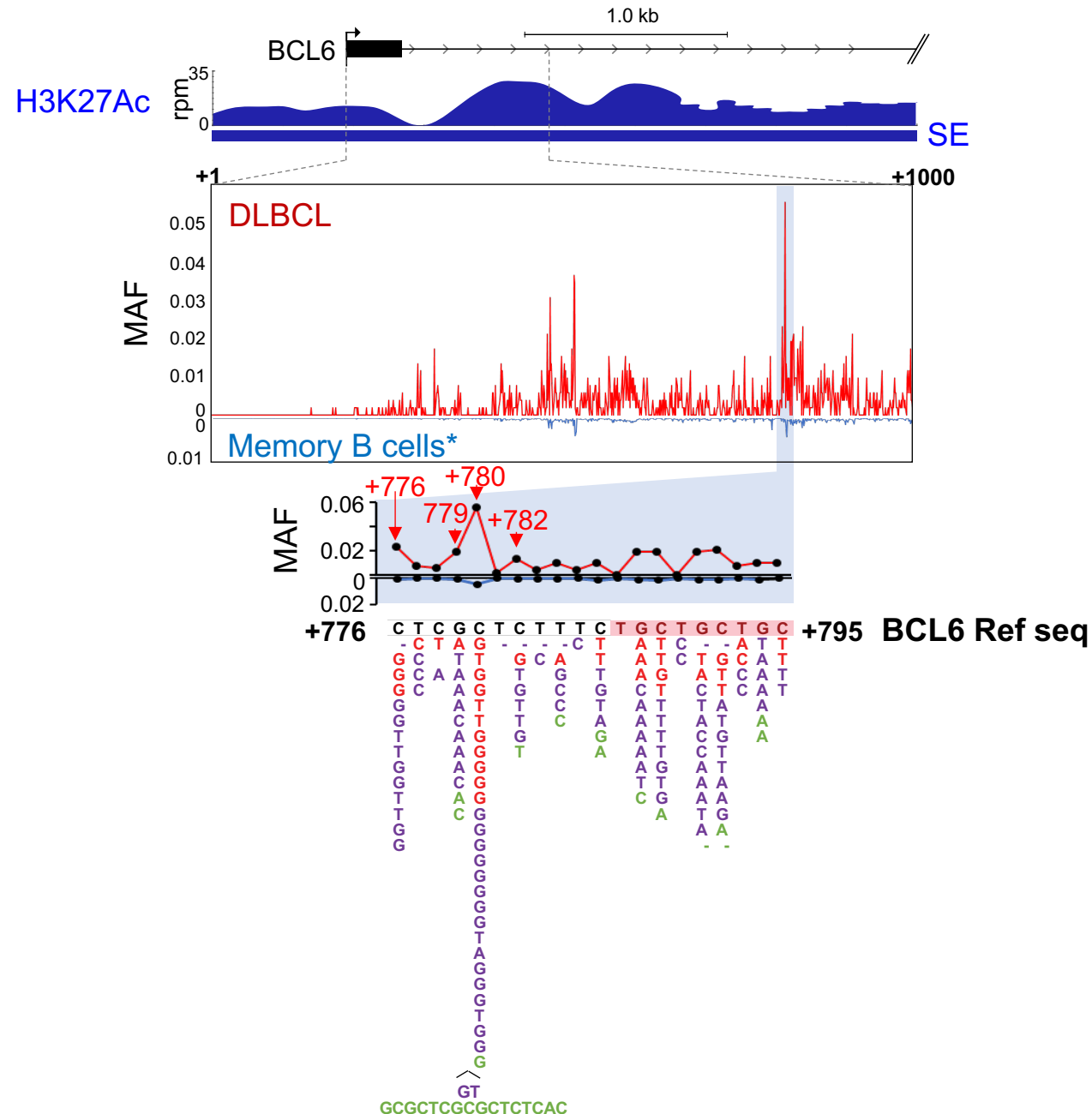

AID motif

Cases tested:

■ primary cases (WGS, n= 75)

■ primary cases (Sanger, n=176)

■ cell lines (WGS, n=23)

(BCL6 Tx excluded)

Recurrent mutations in BCL6 intragenic SE target BLIMP-1 binding site

a. EMSA

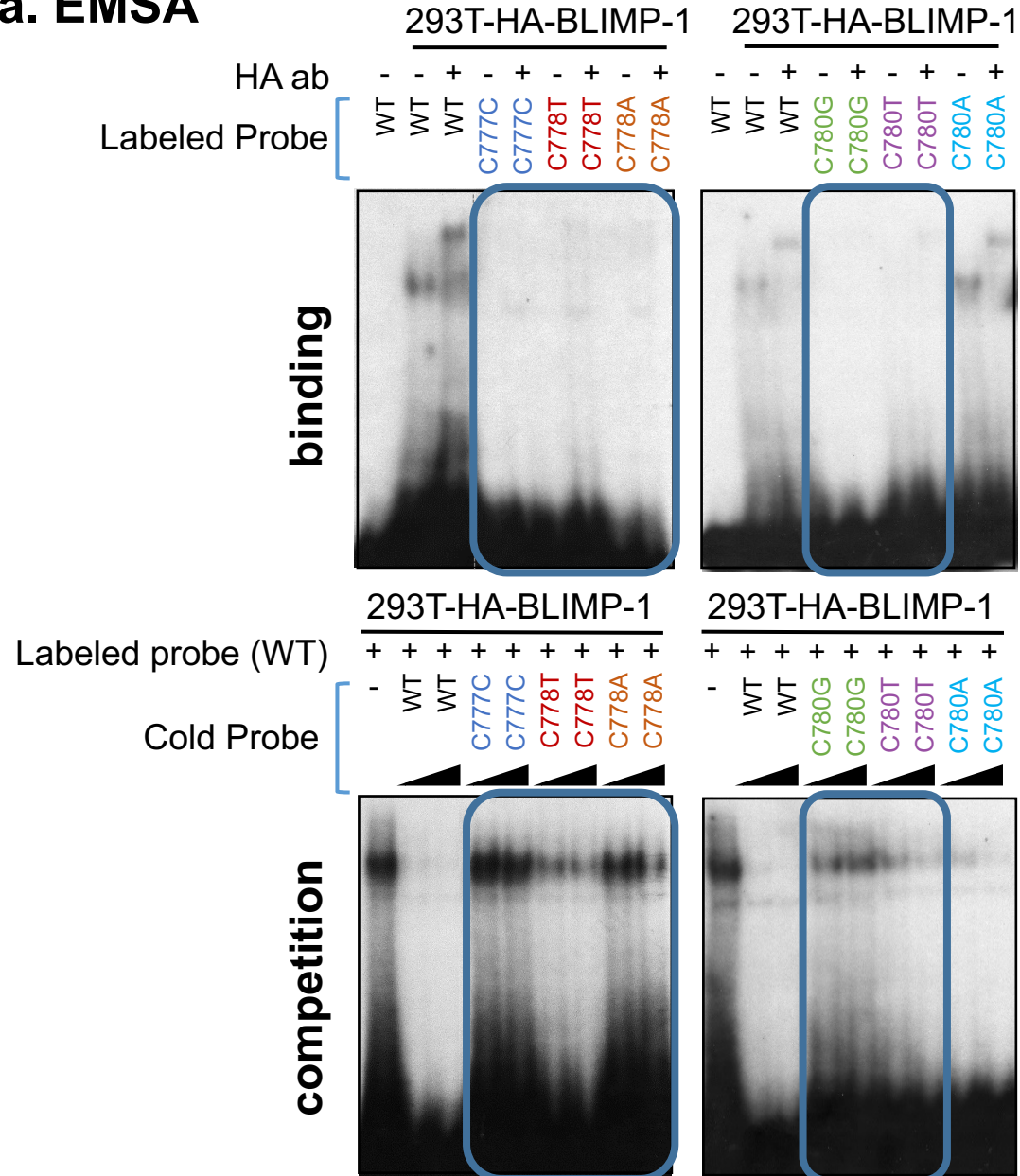

b. ChIP-qPCR (CD40 stimulated cells)

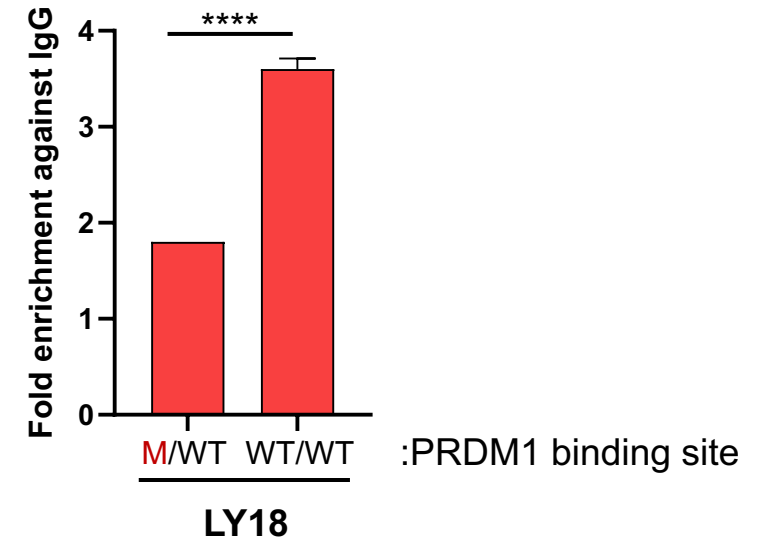
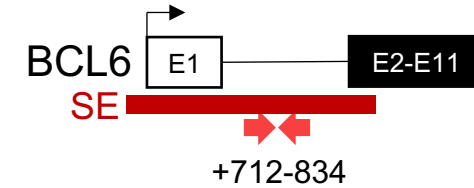
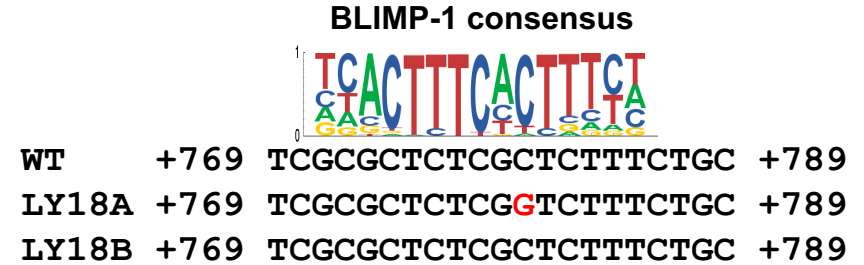

Downregulation of BCL6 expression is required for the initiation of post-GC differentiation

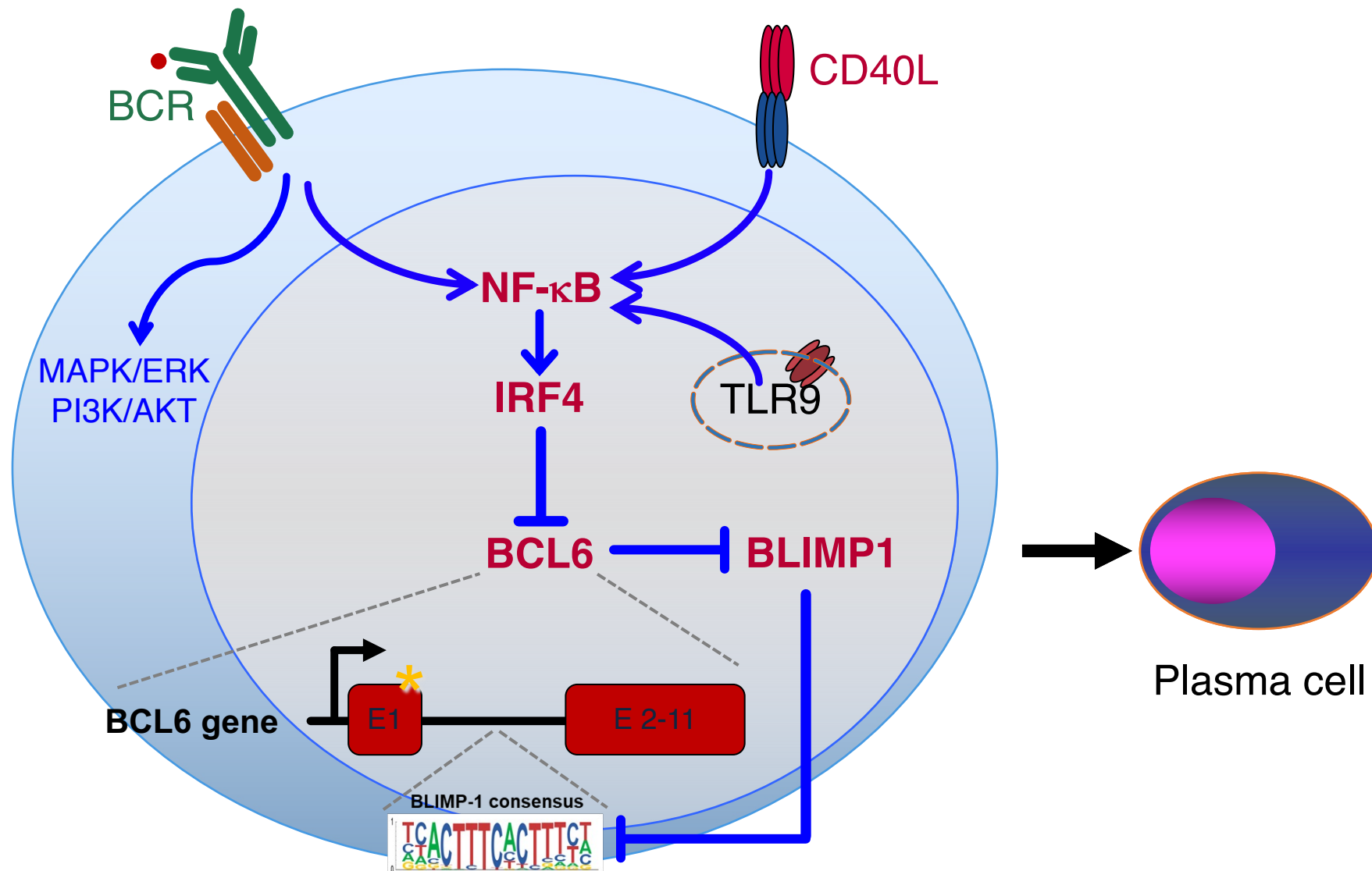

Correction of mutations in BCL6 SE leads to counter-selection

a. CRISPR/Cas9-editing of endogenous site

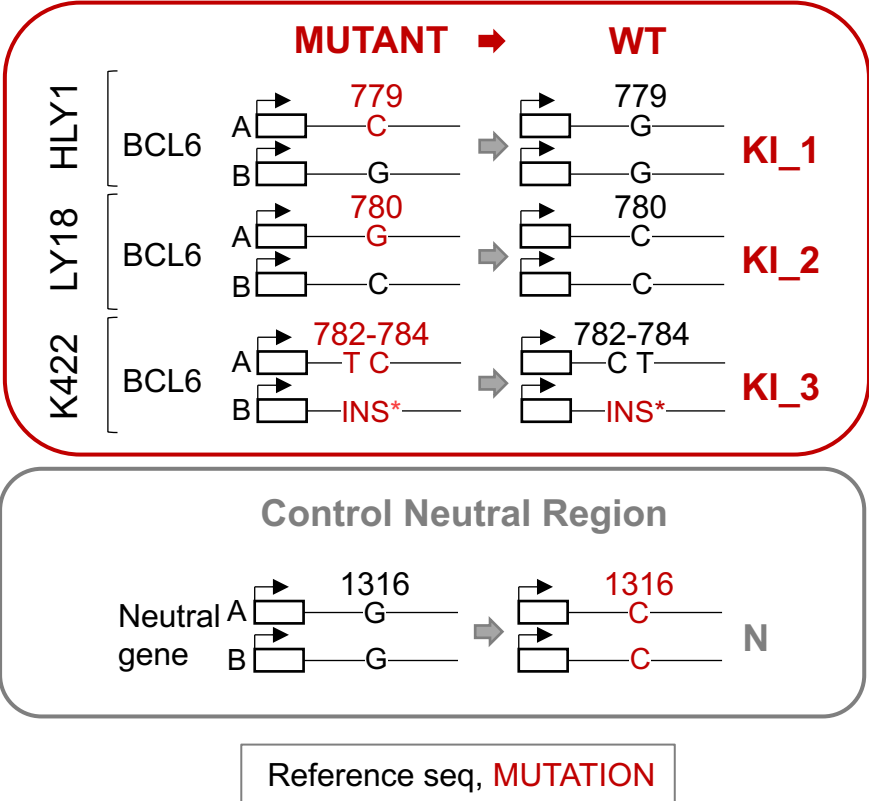

b. Clones Recovery

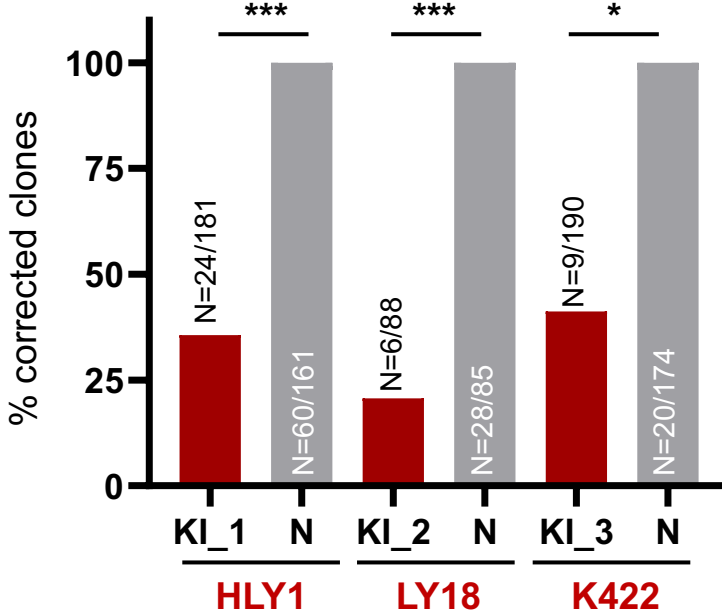

* Ins 16bp 780_781

Recurrent mutations in BCL2 intragenic SE target NR3C1 binding site

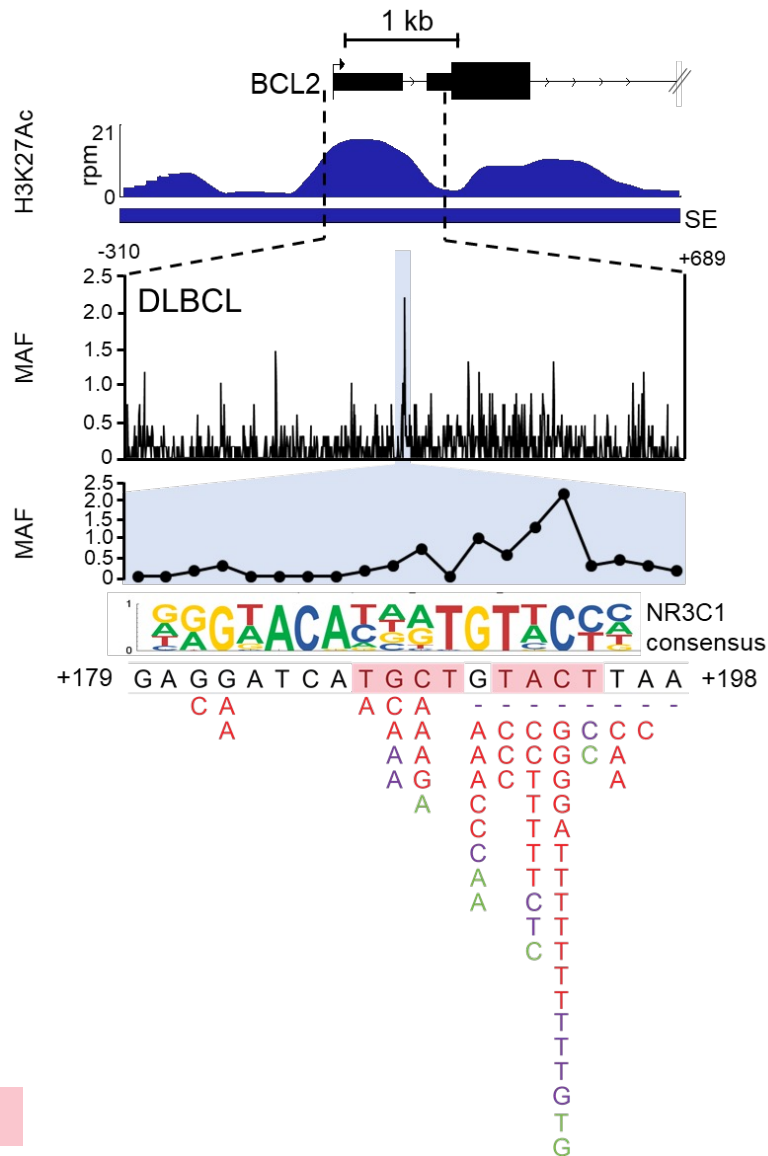

AID motif

(BCL2Tx cases excluded)

NR3C1

- Glucocorticoid receptor and transcription factor
- Truncating mutations in 6% relapsed B-ALL
- Low expression linked to poor prognosis and tumor progression in B-ALL by upregulation of BCL2
- Inversely correlated with BCL2 expression in the GC

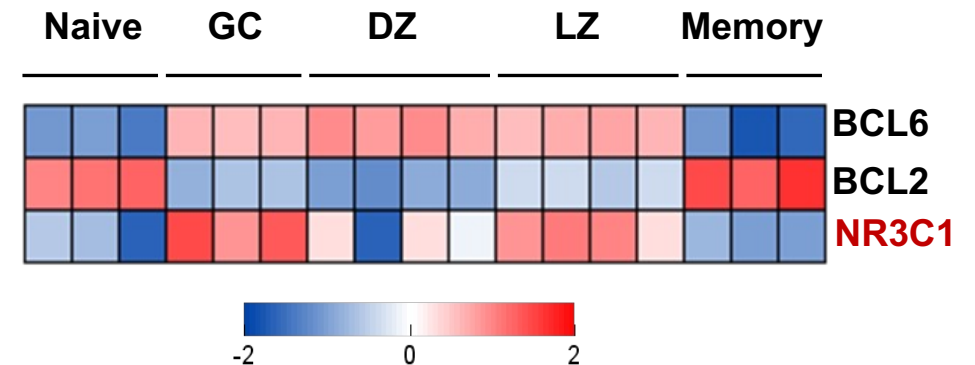

Mutations in BCL2 intragenic SE abrogate NR3C1 binding in DLBCL cells

NR3C1 ChIP-qPCR

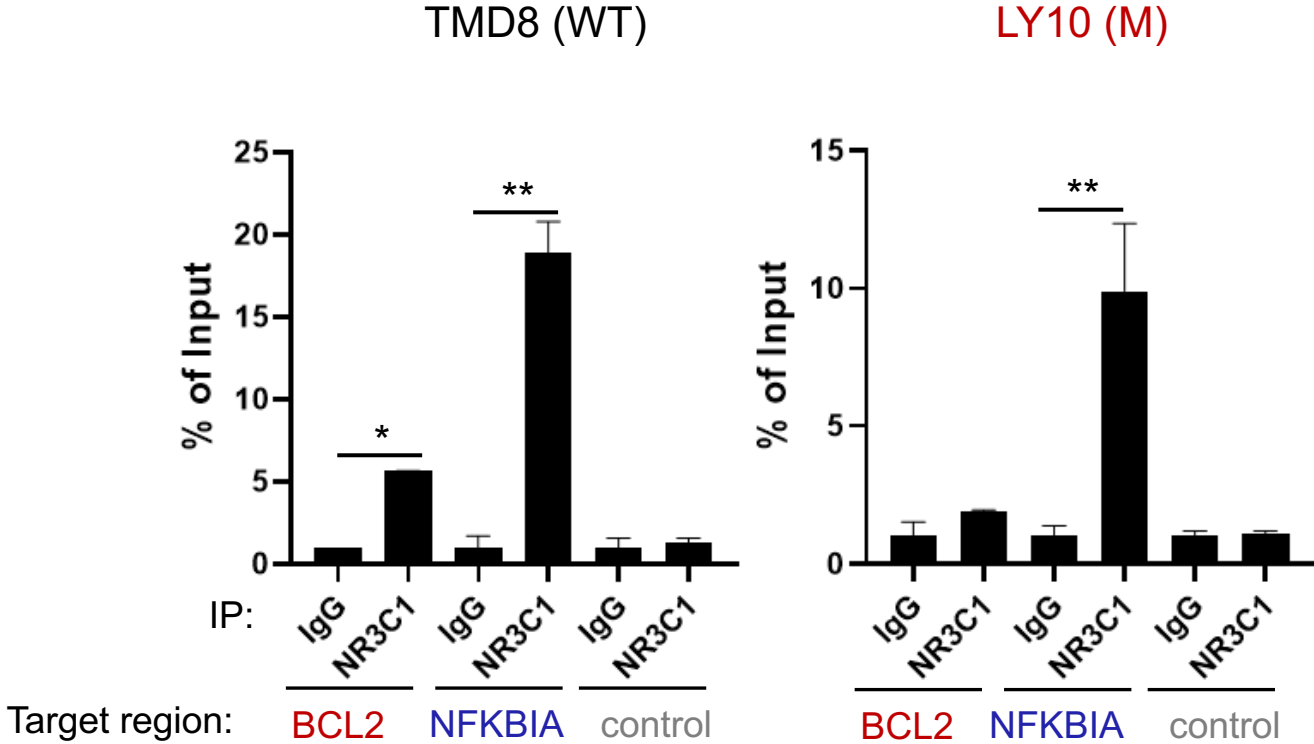

Correction of mutations in BCL2 iSE leads to counter-selection

a. CRISPR/Cas9-editing of endogenous site

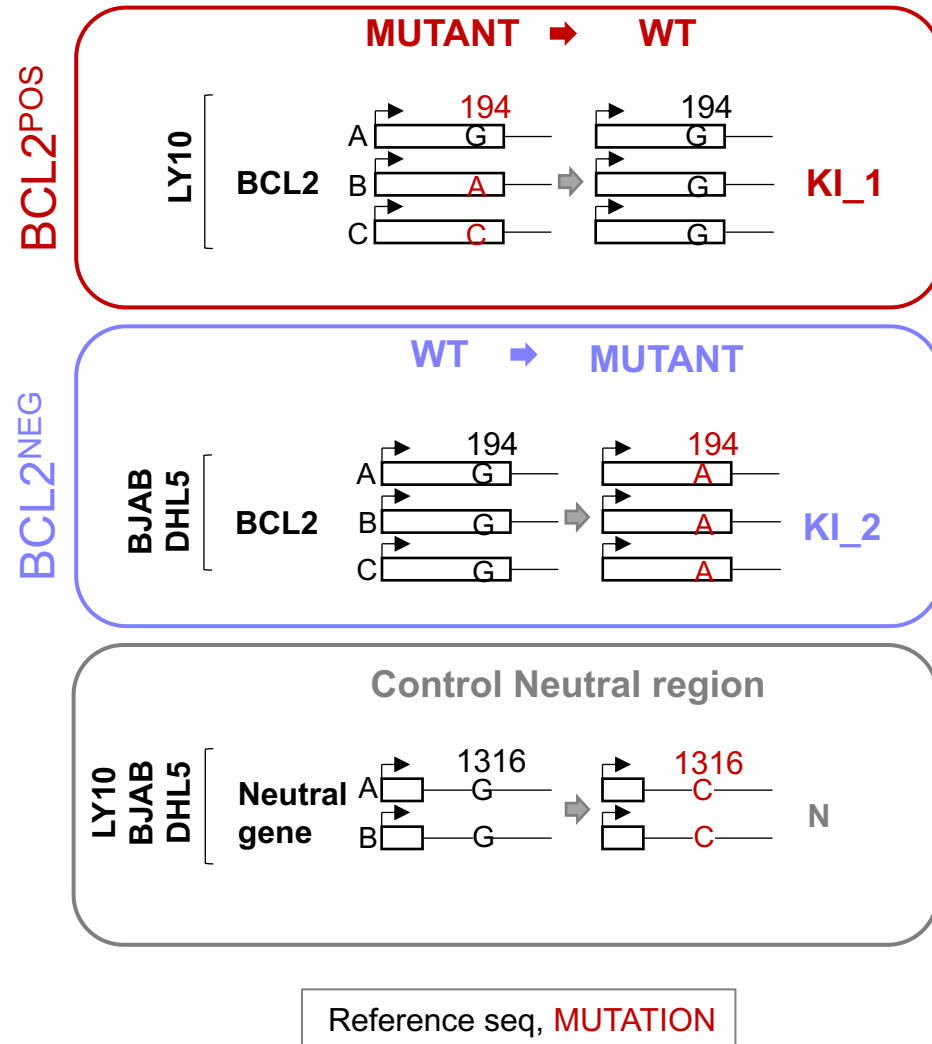

b. Clones Recovery

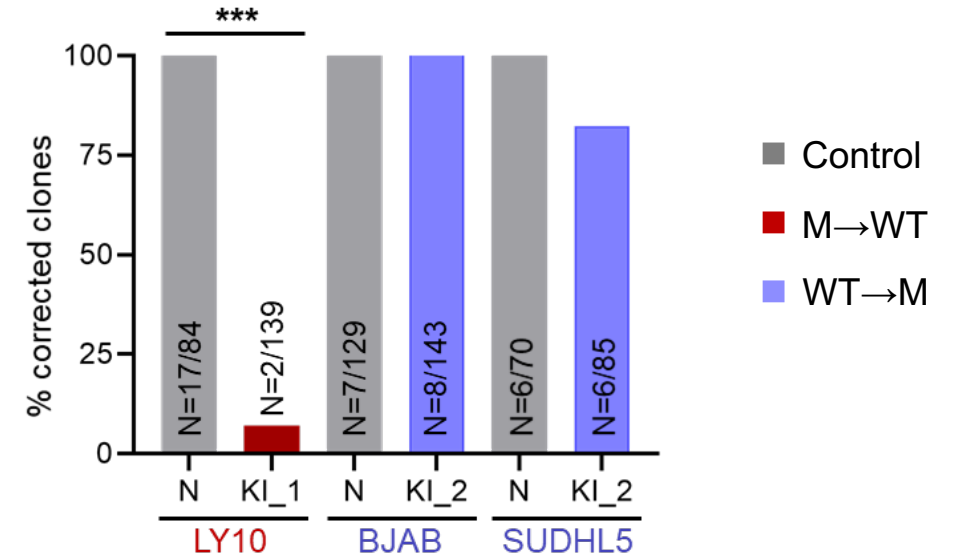

c. BCL2 mRNA expression

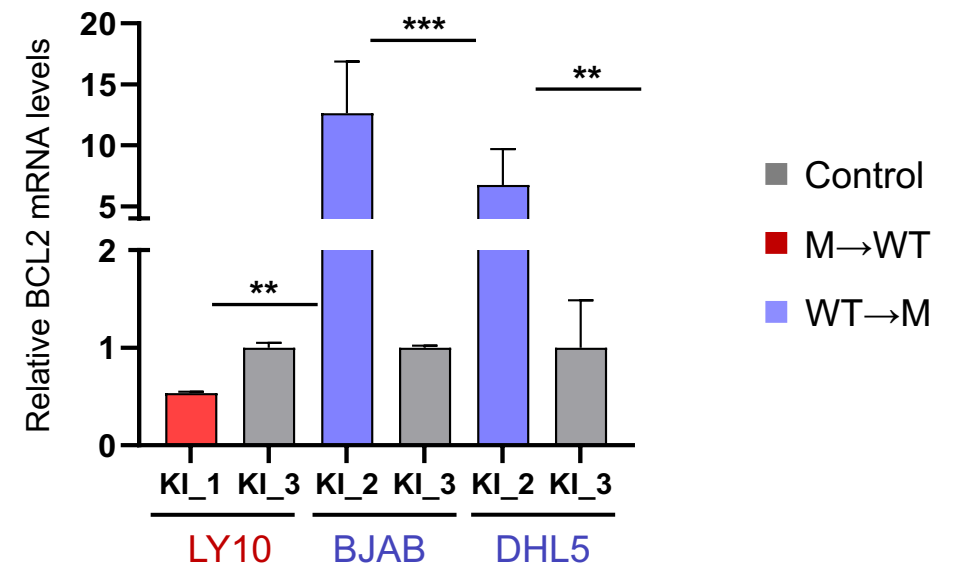

Multiple genetic lesions contribute to BCL2 deregulation in lymphoma

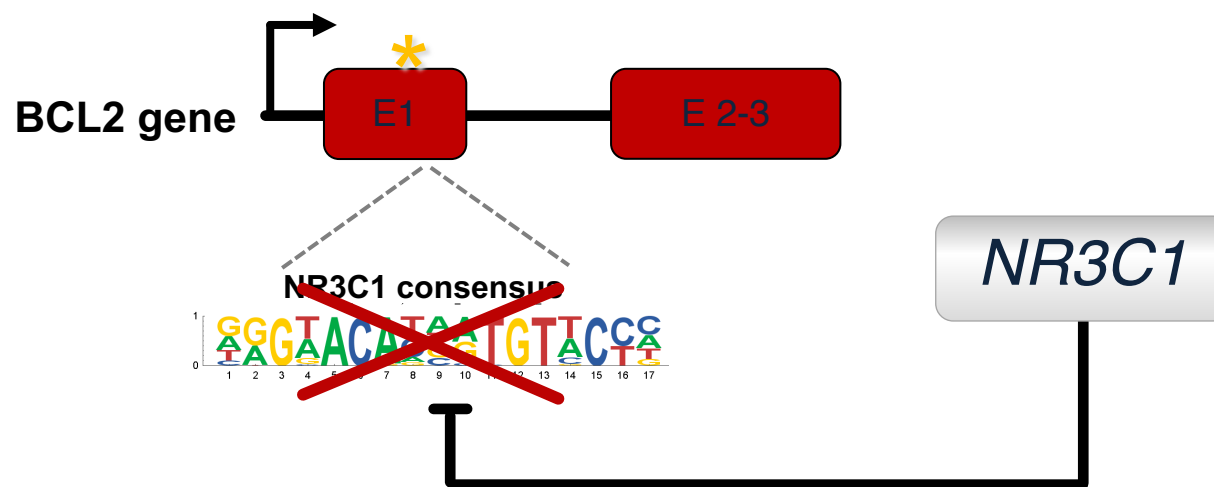
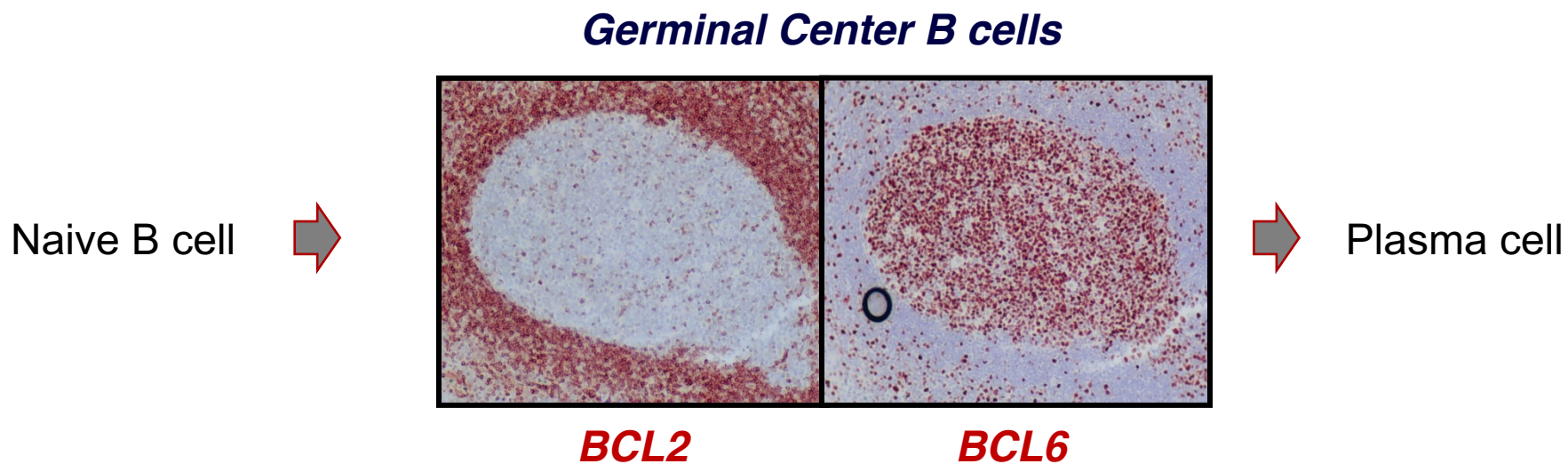

A mutational hotspot in the CXCR4 SE abrogates DNA-binding and transcriptional activation by the glucocorticoid receptor (NR3C1)

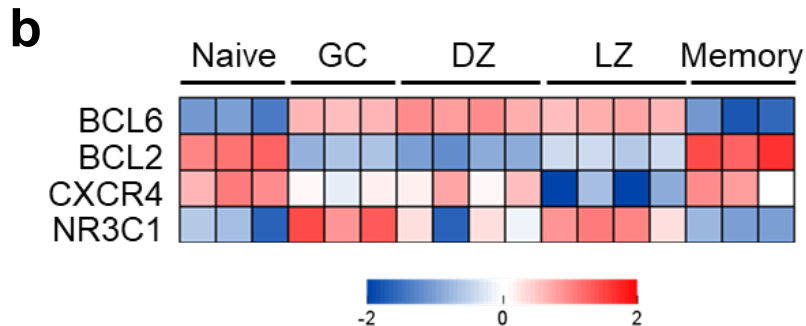
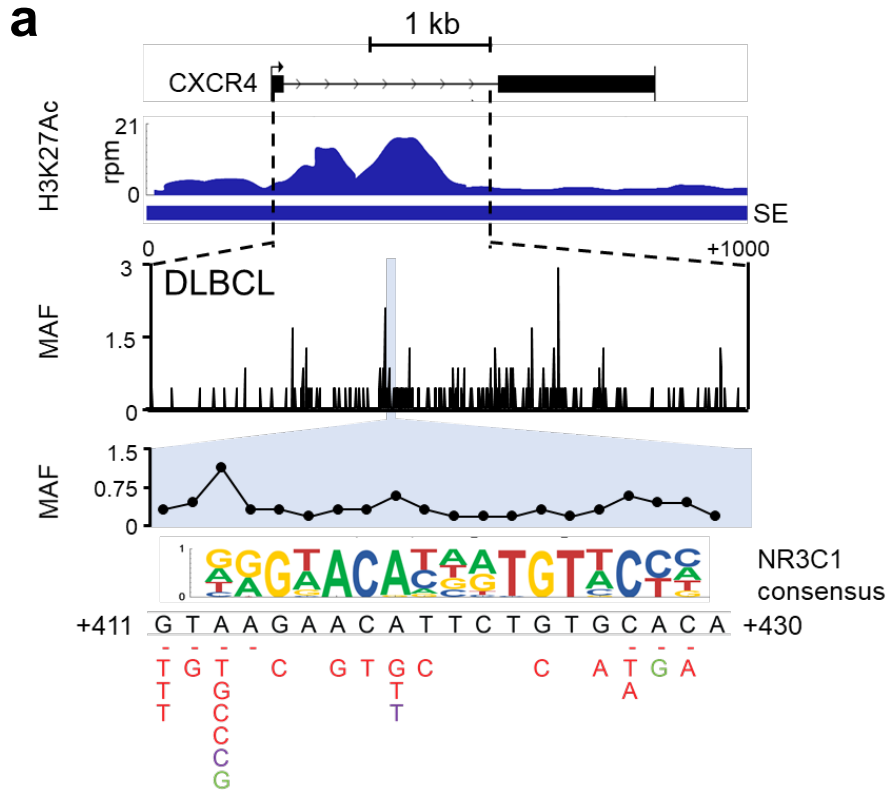

CXCR4

- Transmembrane receptor for the CXCL12/SDF1 chemokine
- Involved in MAPK activation and AKT signaling
- Essential role in cell migration and GC DZ/LZ organization
- Oncogenic truncating mutations in Waldenstrom Macroglobulinemia
- Coding mutations found in few DLBCL cases

c

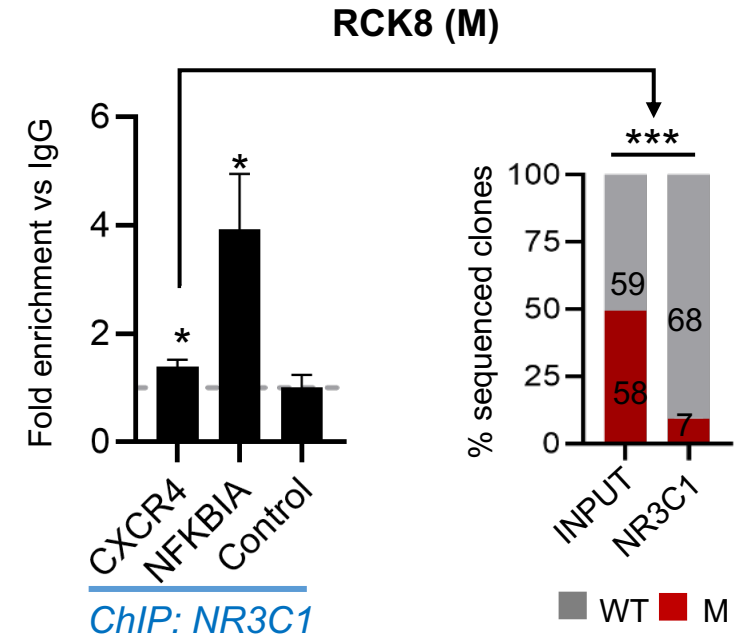
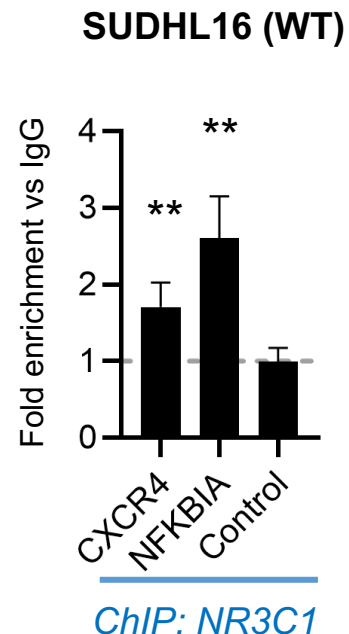

Correction of mutations in the CXCR4 SE induces counter-selection of lymphoma cells

a

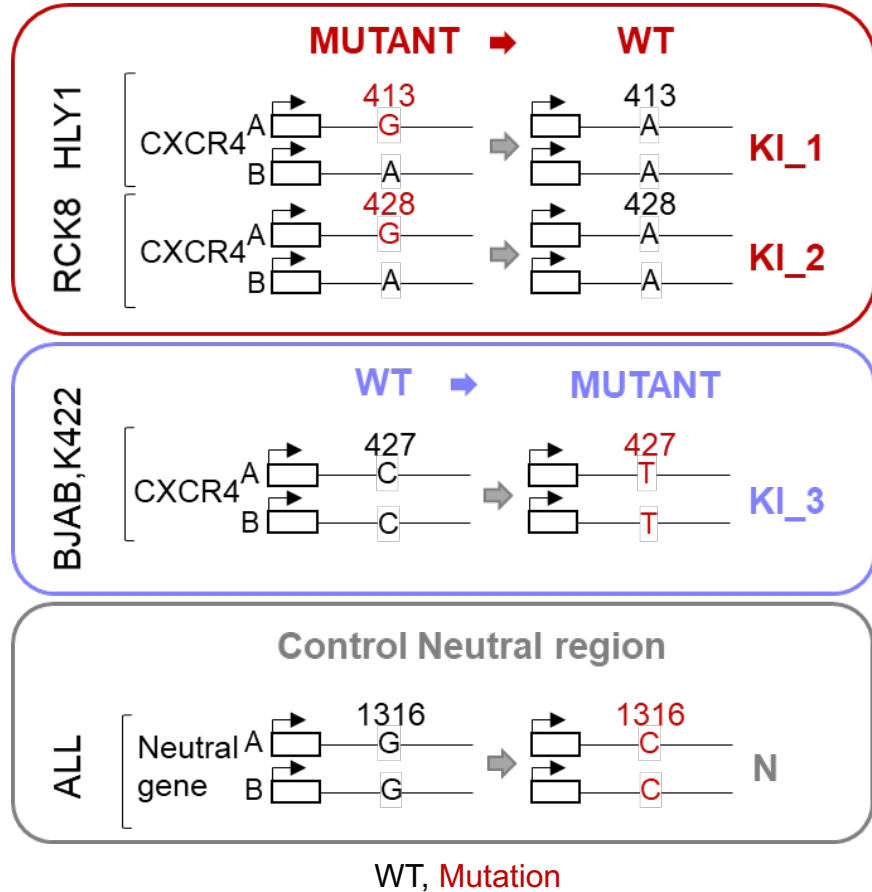

b

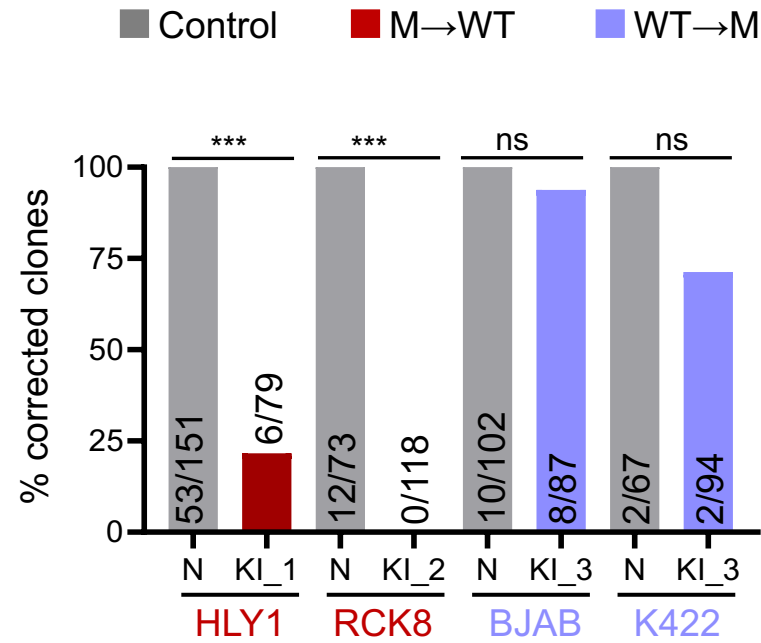

c

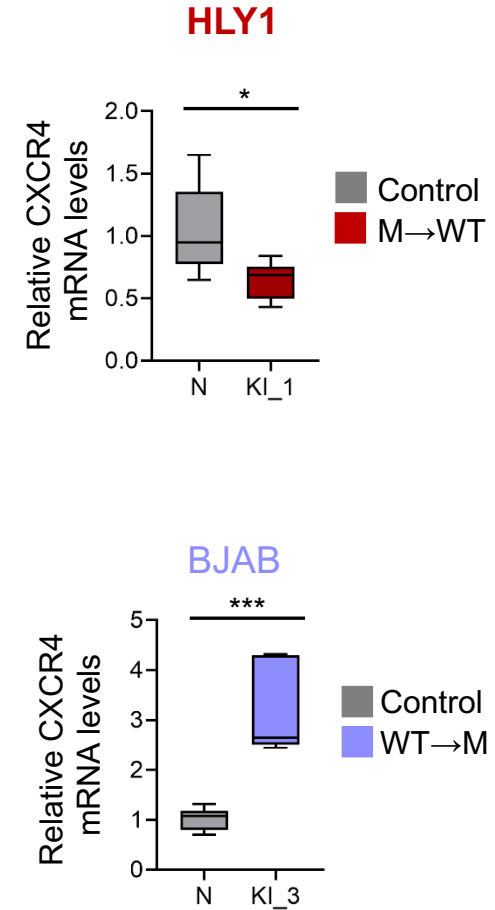

SE-mutations identify complementary mechanisms deregulating target gene expression

BCL6-B1BS M
(78)

BCL6 Tx
(104)

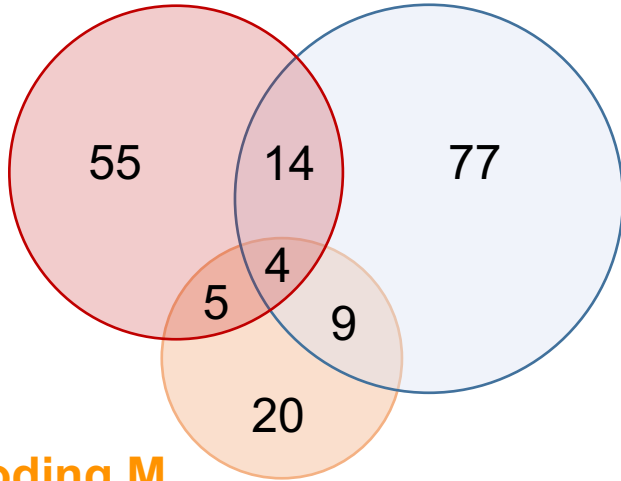

BCL2-NR3C1-BS M
(41)

BCL2 Tx
(90)

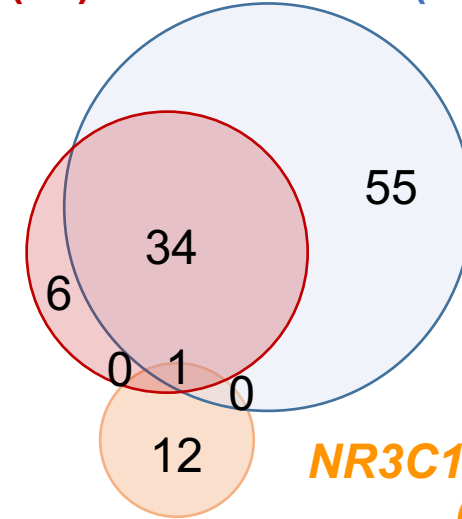

PRDM1 coding M
(38)

NR3C1 coding M
(13)

CXCR4-NR3C1 BS M
(15)

NR3C1 coding M
(13)

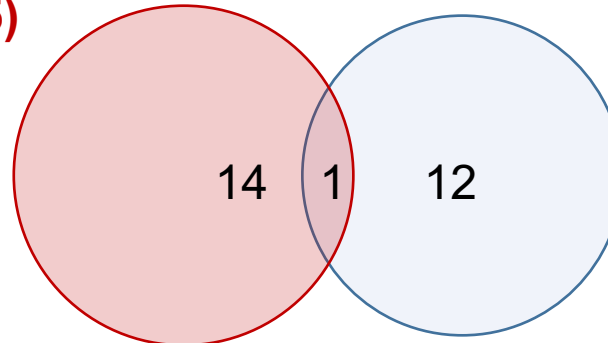

B1BS M = Blimp1 binding site mutations
NR3C1-BS M = NR3C1 binding site mutations
Tx, translocations

Summary

- Super-enhancers (SE) are hypermutated in DLBCL
- SE Mutations are caused by AID
- Mutated SE are often linked to proto-oncogenes, potentially leading to their dysregulation
- Recurrent SE mutation hotspots in the BCL6, BCL2 and CXCR4 loci cause their dysregulated expression
- ~80 SE are mutated (3-70 per case) in 93 cases tested, which identify new altered pathways of pathogenetic and clinical relevance

Institute for Cancer Genetics Columbia University

Elodie Bal

Rahul Kumar
Marco Fangazio
Chuanijang Yu
Qiong Shen
Bowen Cai
Tongwei Mo
Hongyan Tang
Clarissa Corinaldesi
Claudio Scuoppo

Antony Holmes
Katia Basso

Former Members (2008-2018)

Ulf Klein	Madhavi Challa-Malladi
David Dominguez-Sola	Roy Maute
Giulia Fabbri	Yen Lieu
Jonathan Mandelbaum	Mas Saito
Oxana Bereschenko	Urban Novak
Paola Brescia	Marta Crespo
Carol Ying	C. Schneider
	N. Compagno

Stafanie Meyer
Sofija Vlasevska
Mara Holloman
Jiyuan Zhang
Romain Duval
Laura Pasqualucci

Vladimir Trifonov
Erik Ladewig
Raul Rabadan

Collaborators

Hossein Khiabani, Rutgers University
Ryan Morin, Simon Fraser University,
Burnaby, Canada
David Scott, BCCA, Vancouver, Canada
Christian Steidl, BCCA, Vancouver, Canada
Shafinaz Hussein, Mount Sinai Hospital, NY
Amy Chadburn, Cornell University, NY
Raju Chaganti, MSKCC, NY
Stefano Pileri, IEO, Milan (Italy)
Davide Rossi, Bellinzona (Switzerland)
Gianluca Gaidano, Novara (Italy)
Maurilio Ponzoni, Milano (Italy)
Giorgio Inghirami, Cornell University, NY
Pierre Brousset, CRCT Toulouse (France)
Charles Mullighan, St Jude, Memphis
Paul Brindle, St Jude, Memphis
Kai Ge, NIDDK, Bethesda
Govind Bhagat, Columbia University, NY
Murty VV, Columbia University, NY
Andrea Califano, Columbia University, NY
Wei Gu, Columbia University, NY

AID-mediated aberrant somatic hypermutation in DLBCL

Hypermutation of multiple proto-oncogenes in B-cell diffuse large-cell lymphomas

nature
International journal of science

Laura Pasqualucci⁺, Peter Neumeister⁺, Tina Goossens[†],
Gouri Nangud[‡], R. S. K. Chaganti[‡], Ralf Küppers^{†*}
& Riccardo Dalla-Favera^{*}

^{*} Institute for Cancer Genetics and the Department of Pathology, Columbia University, New York, New York 10032, USA

[†] Institute for Genetics, University of Cologne, 50931 Cologne, Germany

[‡] Laboratory of Cancer Genetics and the Department of Medicine, Memorial Sloan-Kettering Cancer Center, New York, New York 10021, USA

Nature, 2001

- ❖ Distribution within ~2Kb from TSS
- ❖ Requires active transcription at target gene
- ❖ Requires AID
- ❖ Overlaps with translocation breakpoint regions
- ❖ Due to malfunction of physiologic SHM mechanism

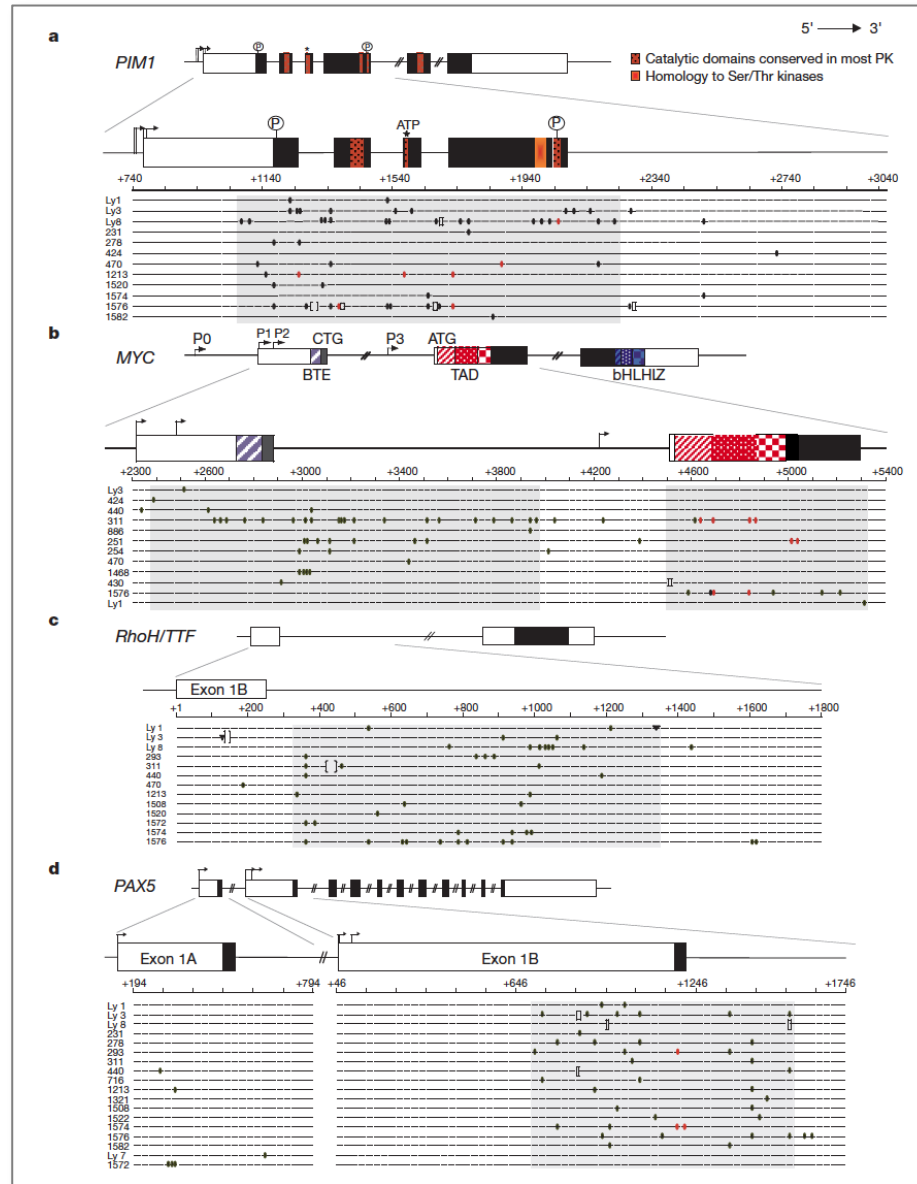

Pasqualucci et al., *PNAS*, 1998
Shen et al., *Science*, 1998
Pasqualucci et al., *Nature*, 2001
Pasqualucci et al., *Nat. Genetics*, 2008
Liu et al., *Nature*, 2008
Khodabakhshi et al., *Oncotarget*, 2012
Arthur et al., *Nat. Communications* 2018

Model for the generation of genetic lesions in B-NHL

Pasqualucci et al., *Nature Genetics* 2008

